

Differential pressure transmitter, model A2G-50

EN

CE

air2guide



Model A2G-50

WIKAI

Part of your business

© 01/2009 WIKA Alexander Wiegand SE & Co. KG
All rights reserved. / Alle Rechte vorbehalten.
WIKA® is a registered trademark in various countries.
WIKA® ist eine geschützte Marke in verschiedenen Ländern.

Prior to starting any work, read the operating instructions!
Keep for later use!

Vor Beginn aller Arbeiten Betriebsanleitung lesen!
Zum späteren Gebrauch aufbewahren!

Contents

1. General information	4
2. Design and function	5
3. Safety	6
4. Transport, packaging and storage	11
5. Commissioning, operation	12
6. Modbus® version	23
7. Maintenance, cleaning and recalibration	27
8. Dismounting, return and disposal	28
9. Specifications	31
10. Accessories	33

Declarations of conformity can be found online at www.wika.com.

1. General information

1. General information

EN

- The differential pressure transmitter described in the operating instructions has been manufactured using state-of-the-art technology. All components are subject to stringent quality and environmental criteria during production. Our management systems are certified to ISO 9001 and ISO 14001.
- These operating instructions contain important information on handling the instrument. Working safely requires that all safety instructions and work instructions are observed.
- Observe the relevant local accident prevention regulations and general safety regulations for the instrument's range of use.
- The operating instructions are part of the product and must be kept in the immediate vicinity of the instrument and readily accessible to skilled personnel at any time. Pass the operating instructions on to the next operator or owner of the instrument.
- Skilled personnel must have carefully read and understood the operating instructions prior to beginning any work.
- The general terms and conditions contained in the sales documentation shall apply.
- Subject to technical modifications.
- Further information:
 - Internet address: www.wika.de / www.wika.com
www.air2guide.com
 - Relevant data sheet: PE 88.02

2. Design and function

2. Design and function

2.1 Overview



EN

- ① Case
- ② Cable gland M16
- ③ Connecting nozzle (ABS), for hoses with inner diameter 4 or 6 mm

2.2 Description

The model A2G-50 differential pressure transmitter is used for measuring differential pressures of gaseous media in ventilation and air-conditioning applications. It is based on the piezoresistive measuring principle.

Electrical analogue output signals for both measurands (0 ... 10 V or 4 ... 20 mA; adjustable in the instrument via jumpers) or the digital Modbus[®] versions enable the direct connection to control systems or the building automation system.

2. Design and function / 3. Safety

2.3 Dimensions in mm

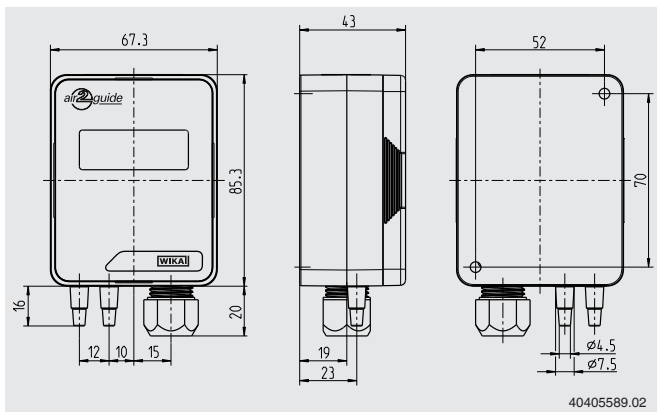

2.4 Scope of delivery

- Differential pressure transmitter
- 2 mounting screws
- 2 duct connectors (option)
- 2 x 2 m PVC measuring hose (option)

Cross-check scope of delivery with delivery note.

3. Safety

3.1 Explanation of symbols



WARNING!

... indicates a potentially dangerous situation that can result in serious injury or death, if not avoided.

3. Safety

EN



CAUTION!

... indicates a potentially dangerous situation that can result in light injuries or damage to property or the environment, if not avoided.



DANGER!

... identifies hazards caused by electrical power. Should the safety instructions not be observed, there is a risk of serious or fatal injury.



WARNING!

... indicates a potentially dangerous situation that can result in burns caused by hot surfaces or liquids, if not avoided.



Information

... points out useful tips, recommendations and information for efficient and trouble-free operation.

3.2 Intended use

This differential pressure transmitter is used for:

- Monitoring the differential pressure of air and other non-flammable and non-aggressive gases
- Monitoring of air filters, blowers in ventilation ducts
- Control of air and fire shutters and for overpressure monitoring in clean rooms and laboratories

This instrument is not permitted to be used in hazardous areas!

The instrument has been designed and built solely for the intended use described here, and may only be used accordingly.

3. Safety

EN

The technical specifications contained in these operating instructions must be observed. Improper handling or operation of the instrument outside of its technical specifications requires the instrument to be taken out of service immediately and inspected by an authorised WIKA service engineer.

The manufacturer shall not be liable for claims of any type based on operation contrary to the intended use.

3.3 Improper use



WARNING!

Injuries through improper use

Improper use of the instrument can lead to hazardous situations and injuries.

- ▶ Refrain from unauthorised modifications to the instrument.
- ▶ Do not use the instrument within hazardous areas.
- ▶ Do not use the instrument with abrasive or viscous media.

Any use beyond or different to the intended use is considered as improper use.

Do not use this instrument in safety or emergency stop devices.

3.4 Responsibility of the operator

The instrument is used in the industrial sector. The operator is therefore responsible for legal obligations regarding safety at work.

The safety instructions within these operating instructions, as well as the safety, accident prevention and environmental protection regulations for the application area must be maintained.

The operator is obliged to maintain the product label in a legible condition.

3. Safety

To ensure safe working on the instrument, the operating company must ensure

- that the operating personnel are regularly instructed in all topics regarding work safety, first aid and environmental protection and know the operating instructions and in particular, the safety instructions contained therein.
- that the instrument is suitable for the particular application in accordance with its intended use.
- that personal protective equipment is available.

EN

3.5 Personnel qualification



WARNING!

Risk of injury should qualification be insufficient

Improper handling can result in considerable injury and damage to equipment.

- ▶ The activities described in these operating instructions may only be carried out by skilled personnel who have the qualifications described below.

Skilled electrical personnel

Skilled electrical personnel are understood to be personnel who, based on their technical training, know-how and experience as well as their knowledge of country-specific regulations, current standards and directives, are capable of carrying out work on electrical systems and independently recognising and avoiding potential hazards. The skilled electrical personnel have been specifically trained for the work environment they are working in and know the relevant standards and regulations. The skilled electrical personnel must comply with current legal accident prevention regulations.

Operating personnel

The personnel trained by the operator are understood to be personnel who, based on their education, knowledge and experience, are capable of carrying out the work described and independently recognising potential hazards.

Special operating conditions require further appropriate knowledge, e.g. of aggressive media.

3. Safety

3.6 Labelling, safety marks

Product label (example)

EN

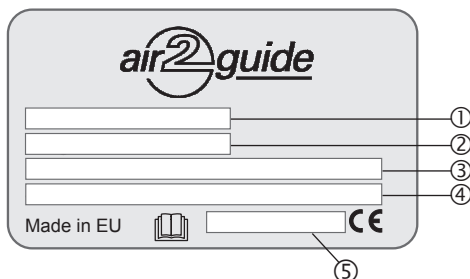

- ① Model
- ② Measuring range
- ③ Output signal
- ④ Power supply
- ⑤ Serial number



Before mounting and commissioning the instrument, ensure you read the operating instructions!

4. Transport, packaging and storage

EN

4. Transport, packaging and storage

4.1 Transport

Check the instrument for any damage that may have been caused by transport.

Obvious damage must be reported immediately.



CAUTION!

Damage through improper transport

With improper transport, a high level of damage to property can occur.

- ▶ When unloading packed goods upon delivery as well as during internal transport, proceed carefully and observe the symbols on the packaging.
- ▶ With internal transport, observe the instructions in chapter 4.2 "Packaging and storage".

If the instrument is transported from a cold into a warm environment, the formation of condensation may result in instrument malfunction. Before putting it back into operation, wait for the instrument temperature and the room temperature to equalise.

4.2 Packaging and storage

Do not remove packaging until just before mounting.

Keep the packaging as it will provide optimum protection during transport (e.g. change in installation site, sending for repair).

Permissible conditions at the place of storage:

- Storage temperature: -20 ... +70 °C

Avoid exposure to the following factors:

- Direct sunlight or proximity to hot objects
- Mechanical vibration, mechanical shock (putting it down hard)
- Soot, vapour, humidity, dust and corrosive gases
- Hazardous environments, flammable atmospheres

4. Transport ... / 5. Commissioning, operation

Store the instrument in its original packaging in a location that fulfils the conditions listed above. If the original packaging is not available, pack and store the instrument as described below:

EN

1. Wrap the instrument in an antistatic plastic film.
2. Place the instrument, along with the shock-absorbent material, in the packaging.
3. If stored for a prolonged period of time (more than 30 days), place a bag containing a desiccant inside the packaging.

5. Commissioning, operation

Personnel: Skilled electrical personnel

Tools: Voltage tester, screwdriver

Only use original parts (see chapter 10 “Accessories”).



WARNING!

Physical injuries and damage to property and the environment caused by hazardous media

Upon contact with hazardous media (e.g. oxygen, acetylene, flammable or toxic substances), harmful media (e.g. corrosive, toxic, carcinogenic, radioactive), and also with refrigeration plants and compressors, there is a danger of physical injuries and damage to property and the environment.

Should a failure occur, aggressive media with extremely high temperature and under high pressure or vacuum may be present at the instrument.

- ▶ For these media, in addition to all standard regulations, the appropriate existing codes or regulations must also be followed.



CAUTION!

Damage to the instrument

When working on open electrical circuits (printed circuit boards) there is a risk of damaging sensitive electronic components through electrostatic discharge.

- ▶ The correct use of grounded working surfaces and personal armbands is required.

5. Commissioning, operation



DANGER!

Danger to life caused by electric current

Upon contact with live parts, there is a direct danger to life.

- ▶ The instrument may only be installed and mounted by skilled personnel.
- ▶ Operation using a defective power supply unit (e.g. short circuit from the mains voltage to the output voltage) can result in life-threatening voltages at the instrument!

EN

1. Instrument fixing at the desired mounting location (see chapter 5.1 “Instrument mounting”)
2. Opening the instrument cover, feeding the connection cable through the cable gland and connecting the wires to the terminal block (see chapter 5.2 “Electrical mounting”)
3. The instrument is now ready for configuration (see chapter 5.3 “Configuration”)

5. Commissioning, operation

5.1 Instrument mounting

Screw the differential pressure transmitter onto a suitable vertical surface and fix it horizontally with the mounting screws delivered with the instrument.

EN

1. Select a mounting location (duct, wall, panel).
2. Remove the case cover and use the screw holes as a template.
3. Mount with suitable screws.

Instrument fixing

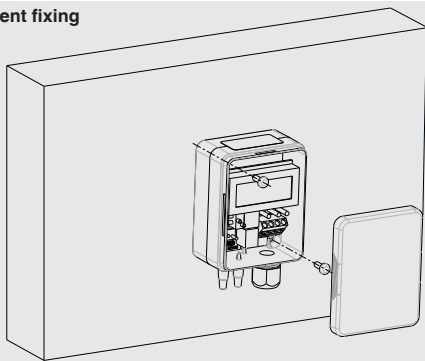

Instrument orientation



5. Commissioning, operation

EN

Application-related connections

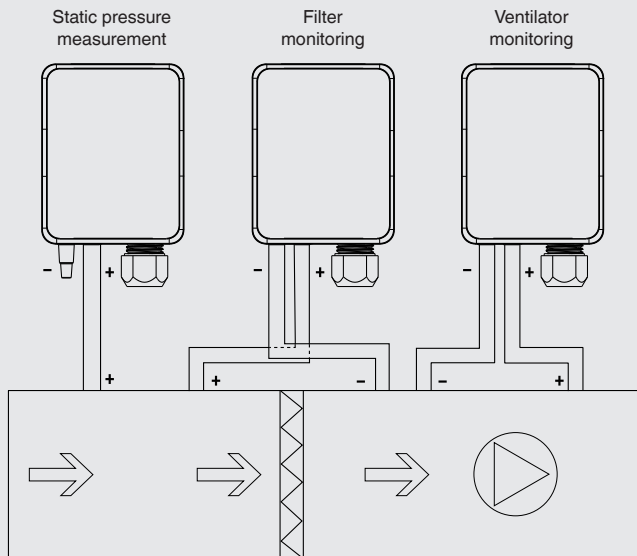

5. Commissioning, operation

5.2 Electrical mounting

The instrument is designed to operate with safety extra-low voltage (SELV). As a rule, operate the differential pressure transmitter in the middle of the measuring range, since deviations can occur at the range limits.

EN

Operate the A2G-50 with a constant operating voltage (± 0.2 V) and ambient temperature. Prevent current/voltage spikes from switching the power supply on or off.

For CE conformity, a properly grounded protective cable is required.

1. Unscrew the strain relief and feed the cable(s) through.
2. Connect the wires (see "Connection diagram").
3. Tighten down the strain relief.

Connection diagram

- Output signal DC 0 ... 10 V

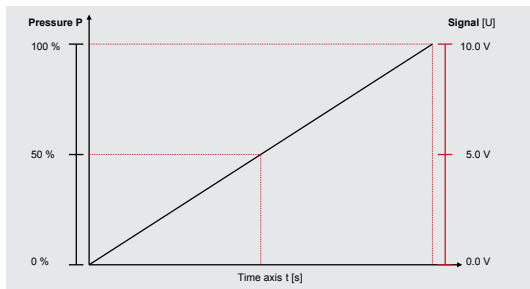
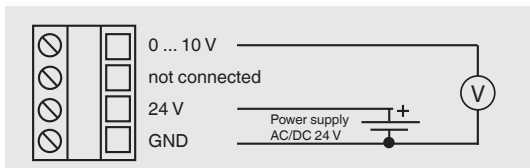

5. Commissioning, operation

■ Output signal 4 ... 20 mA

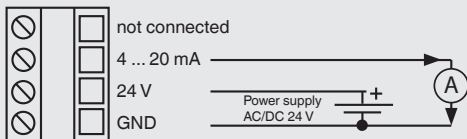

EN

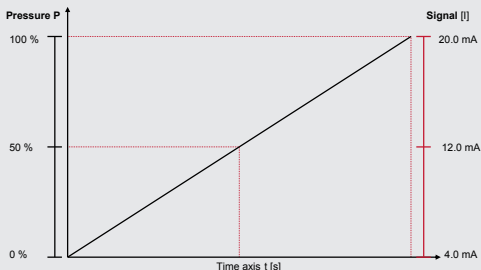

5.3 Configuration

1. Remove the case cover.
2. Select the desired pressure unit (see chapter 5.4).
3. Select the desired measuring range (see chapter 5.5).
4. Select the desired response time (see chapter 5.6).
5. Carry out a zero point setting (see chapter 5.7).
6. Connect measurement hoses.
(overpressure = connection "+", vacuum = connection "-")
7. Close the cover.

The instrument is now ready for operation.

5. Commissioning, operation

5.4 Selection of the pressure unit (only for the optional version with display)

1. In order to change the pressure unit shown on the display, insert a jumper between both J5 pins (see figure "Storing the jumper").
2. Then press the "zero point setting" button and the various pressure units (Pa, kPa, inchWC, mmWC, psi) will be shown on the display.
3. Remove the jumper from J5 in order to select the desired unit which should be shown on the display.

EN

Installing the jumpers

(Dark grey colour indicates the jumper placement)

No jumper
Circuit open

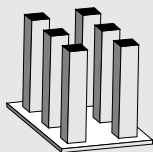

Jumper installed
Circuit closed

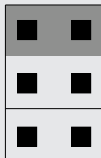
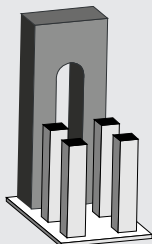

Storing the
jumper

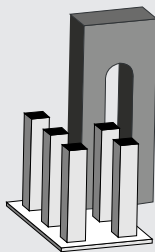

5. Commissioning, operation

5.5 Selecting the measuring range

1. Determine the correct pressure range.
2. Determine the version of the measuring instrument (see table 1).
3. Determine the desired pressure unit (see chapter 5.4).
4. Find the desired measuring range number (see "Range" in illustration).
5. Place jumpers J1, J2 and J3 to set the desired pressure range in accordance with the illustration.

EN

A2G-50 versions and settable pressure ranges

Version 1

MB	Pressure unit					
	Pa	kPa	mbar	inchWC	mmWC	psi
1	-100 ... +100	-0.10 ... +0.10	-1.00 ... +1.00	-0.40 ... +0.40	-10.2 ... +10.2	-0.0145 ... +0.0145
2	0 ... 100	0 ... 0.10	0 ... 1.0	0 ... 0.40	0 ... 10.2	0 ... 0.0145
3	0 ... 250	0 ... 0.25	0 ... 2.50	0 ... 1.00	0 ... 25.5	0 ... 0.0363
4	0 ... 500	0 ... 0.50	0 ... 5.00	0 ... 2.00	0 ... 51.0	0 ... 0.0725
5	0 ... 1,000	0 ... 1.00	0 ... 10.0	0 ... 4.00	0 ... 102.0	0 ... 0.1450
6	0 ... 1,500	0 ... 1.50	0 ... 15.0	0 ... 6.00	0 ... 153.0	0 ... 0.21725
7	0 ... 2,000	0 ... 0.20	0 ... 20.0	0 ... 8.00	0 ... 204.0	0 ... 0.2900
8	0 ... 2,500	0 ... 2.50	0 ... 25.0	0 ... 10.00	0 ... 255.0	0 ... 0.3625

Version 2

MB	Pressure unit					
	Pa	kPa	mbar	inchWC	mmWC	psi
1	0 ... 1,000	0 ... 1.0	0 ... 10.0	0 ... 4.00	0 ... 102.0	0 ... 0.1450
2	0 ... 1,500	0 ... 1.5	0 ... 15.0	0 ... 6.00	0 ... 153.0	0 ... 0.21725
3	0 ... 2,000	0 ... 2.0	0 ... 20.0	0 ... 8.00	0 ... 204.0	0 ... 0.2900
4	0 ... 2,500	0 ... 2.5	0 ... 25.0	0 ... 10.00	0 ... 255.0	0 ... 0.3625
5	0 ... 3,000	0 ... 3.0	0 ... 30.0	0 ... 12.00	0 ... 306.0	0 ... 0.4350
6	0 ... 4,000	0 ... 4.0	0 ... 40.0	0 ... 16.00	0 ... 408.0	0 ... 0.5800
7	0 ... 5,000	0 ... 5.0	0 ... 50.0	0 ... 20.00	0 ... 510.0	0 ... 0.7250
8	0 ... 7,000	0 ... 7.0	0 ... 70.0	0 ... 28.00	0 ... 714.0	0 ... 1.0150

MB = measuring range

5. Commissioning, operation

Version 3

EN

MB	Pressure unit					
	Pa	kPa	mbar	inchWC	mmWC	psi
1	0 ... 25	0 ... 0.025	0 ... 0.25	0 ... 0.10	0 ... 2.6	0 ... 0.0036
2	0 ... 50	0 ... 0.05	0 ... 0.50	0 ... 0.20	0 ... 5.1	0 ... 0.0073
3	0 ... 100	0 ... 0.10	0 ... 1.00	0 ... 0.40	0 ... 10.2	0 ... 0.0145
4	0 ... 250	0 ... 0.25	0 ... 2.50	0 ... 1.00	0 ... 25.5	0 ... 0.0363
5	-25 ... +25	-0.025 ... +0.025	-0.25 ... +0.25	-0.10 ... +0.10	-2.6 ... +2.6	-0.0036 ... +0.0036
6	-50 ... +50	-0.05 ... +0.05	-0.50 ... +0.50	-0.20 ... +0.20	-5.1 ... +5.1	-0.0073 ... +0.0073
7	-100 ... +100	-0.1 ... +0.1	-1.00 ... +1.00	-0.40 ... +0.40	-10.2 ... +10.2	-0.0145 ... +0.0145
8	-250 ... +250	-0.25 ... +0.25	-2.50 ... +2.50	-1.00 ... +1.00	-25.50 ... +25.50	-0.0363 ... +0.0363

MB = measuring range

Jumper placement to set the measuring range

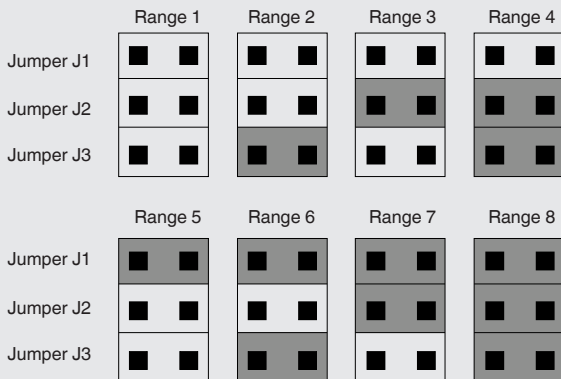

40202780.03 07/2017 EN/DE

5.6 Setting the response time

The response time affects how fast the transmitter reacts to changes in the pressure conditions in the system. The response time defines the time the measuring instrument needs in order to reach 63 % of the measured value. For unstable pressure conditions, select a longer response time.

Example:

Selected response time: 4.0 seconds

Result: The output signal reaches a new value in 20 seconds (response time * 5)

In order to change the response time, install or remove a jumper in slot J4.

- Jumper in slot J4 - 4.0 seconds response time.
- No jumper in slot J4 = 0.8 seconds response time

5. Commissioning, operation

5.7 Zero point setting

5.7.1 Standard

Connect the voltage supply one hour before the zero point setting!

EN

1. Remove both hoses from the pressure connections \oplus and \ominus .
2. Press the zero button until the red LED switches on.
3. Wait until the LED switches off again and install the hoses to the pressure connections again.
4. In normal operation, we recommend that a zero point calibration is carried out every 12 months.

5.7.2 Automatic zero point setting (option)

The automatic zero point setting makes the instrument maintenance-free. The element corrects the zero point from time to time and thus prevents a zero-point drift in the piezoresistive sensor element.

During the zero point setting the display and output value remains at the last measured value. The automatic zero point setting takes 3 seconds and is repeated every 10 minutes.

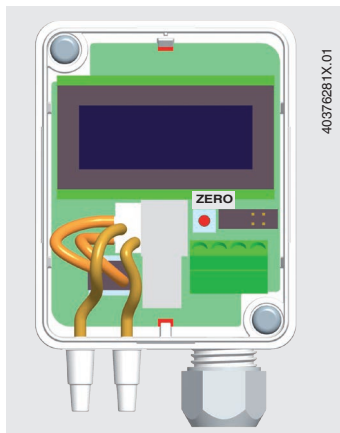

6. Modbus® version

6. Modbus® version

1. Select function mode

Move the “SELECT” button in any direction for at least 2 seconds to enter the menu.

- ▶ “MENU” is displayed.

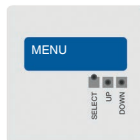

EN

2. Select Modbus® address: 1 ... 247

Move the “DOWN” button once, shortly.

- ▶ “ADDRESS” menu item is displayed



Move the “SELECT” button once, shortly, in order to activate the “ADDRESS” selection.

- ▶ “ADDRESS” menu item flashes

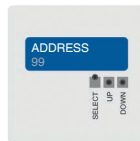

Use “UP” or “DOWN” to find the desired Modbus® address.

- ▶ Selection is displayed.



Move the “SELECT” button once, shortly, in order to accept the selection.

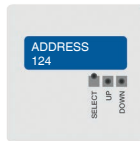

6. Modbus® version

3. Select the baud rate: 9,600, 19,200, 38,400

Move the “DOWN” button once, shortly.

- ▶ “BAUD RATE” menu item is displayed

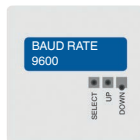

Move the “SELECT” button once, shortly, in order to activate the “BAUD RATE” selection.

- ▶ “BAUD RATE” menu item flashes

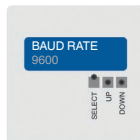

Use “UP” or “DOWN” to find the desired baud rate.

- ▶ Selection is displayed

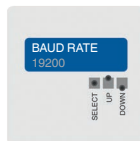

Move the “SELECT” button once, shortly, in order to accept the selection.

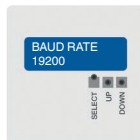

6. Modbus® version

EN

4. Select the parity bit: None, even, odd

Move the “DOWN” button once, shortly.

- ▶ “PARITY BIT” menu item is displayed



Move the “SELECT” button once, shortly, in order to activate the “PARITY BIT” selection.

- ▶ “PARITY BIT” menu item flashes



Use “UP” or “DOWN” to find the desired parity bit.

- ▶ Selection is displayed



Move the “SELECT” button once, shortly, in order to accept the selection.



6. Modbus® version

5. Select the pressure unit: Pa, inchWC, mmWC, psi or mbar

Move the “DOWN” button once, shortly.

- ▶ “PRESS.UNIT” menu item is displayed

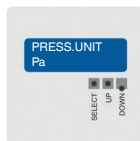

Move the “SELECT” button once, shortly, in order to activate the “PRESS.UNIT” selection.

- ▶ “PRESS.UNIT” menu item flashes

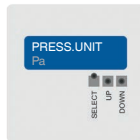

Use “UP” or “DOWN” to find the desired pressure unit.

- ▶ Selection is displayed



Move the “SELECT” button once, shortly, in order to accept the selection.



6. Press the “SELECT” button in order to exit the menu.



7. Maintenance, cleaning and recalibration

7. Maintenance, cleaning and recalibration

Personnel: Skilled electrical personnel

Tools: Voltage tester, screwdriver

EN



For contact details see chapter 1 “General information” or the back page of the operating instructions.

7.1 Maintenance

This instrument is maintenance-free.

Repairs must only be carried out by the manufacturer or appropriately qualified skilled personnel.

Only use original parts (see chapter 10 “Accessories”).

7.2 Cleaning



CAUTION!
Physical injuries and damage to property and the environment

Improper cleaning may lead to physical injuries and damage to property and the environment. Residual media in the dismantled instrument can result in a risk to persons, the environment and equipment.

► Carry out the cleaning process as described below.

1. Before cleaning, correctly disconnect the instrument from the pressure supply, switch it off and disconnect it from the mains.
2. Use the requisite protective equipment.
3. Clean the instrument with a moist cloth (soapy water).
Electrical connections must not come into contact with moisture!



CAUTION!

Damage to the instrument

Improper cleaning may lead to damage to the instrument!

- ▶ Do not use any aggressive cleaning agents.
- ▶ Do not use any hard or pointed objects for cleaning.

EN

4. Wash or clean the dismantled instrument, in order to protect persons and the environment from exposure to residual media.

7.3 Recalibration

DKD/DAkkS certificate - official certificates:

We recommend that the instrument is regularly recalibrated by the manufacturer, with time intervals of approx. 12 months. The basic settings will be corrected if necessary.

8. Dismounting, return and disposal

Personnel: Skilled electrical personnel

Tools: Voltage tester, screwdriver



WARNING!

Physical injuries and damage to property and the environment through residual media

Residual media in the dismantled instrument can result in a risk to persons, the environment and equipment.

- ▶ Observe the information in the material safety data sheet for the corresponding medium.
- ▶ Wash or clean the dismantled instrument, in order to protect persons and the environment from exposure to residual media.

8. Dismounting, return and disposal

8.1 Dismounting

EN



WARNING!

Physical injuries and damage to property and the environment through residual media

Upon contact with hazardous media (e.g. oxygen, acetylene, flammable or toxic substances), harmful media (e.g. corrosive, toxic, carcinogenic, radioactive), and also with refrigeration plants and compressors, there is a danger of physical injuries and damage to property and the environment.

- ▶ Before storage of the dismantled instrument (following use) wash or clean it, in order to protect persons and the environment from exposure to residual media.
- ▶ Observe the information in the material safety data sheet for the corresponding medium.



WARNING!

Risk of burns

During dismantling there is a risk of dangerously hot media escaping.

- ▶ Let the instrument cool down sufficiently before dismantling it!



DANGER!

Danger to life caused by electric current

Upon contact with live parts, there is a direct danger to life.

- ▶ The dismantling of the instrument may only be carried out by skilled personnel.
- ▶ Remove the differential pressure transmitter once the system has been isolated from power sources.

8. Dismounting, return and disposal



WARNING! **Physical injury**

When dismounting, there is a danger from aggressive media and high pressures.

- ▶ Observe the information in the material safety data sheet for the corresponding medium.
- ▶ Remove the differential pressure transmitter once the system has been depressurised.

EN

8.2 Return

Strictly observe the following when shipping the instrument:

All instruments delivered to WIKA must be free from any kind of hazardous substances (acids, bases, solutions, etc.) and must therefore be cleaned before being returned.



WARNING! **Physical injuries and damage to property and the environment through residual media**

Residual media in the dismantled instrument can result in a risk to persons, the environment and equipment.

- ▶ With hazardous substances, attach the material safety data sheet for the corresponding medium.
- ▶ Clean the instrument, see chapter 7.2 "Cleaning".

When returning the instrument, use the original packaging or a suitable transport packaging.

To avoid damage:

1. Wrap the instrument in an antistatic plastic film.
2. Place the instrument, along with the shock-absorbent material, in the packaging.
Place shock-absorbent material evenly on all sides of the transport packaging.
3. If possible, place a bag, containing a desiccant, inside the packaging.
4. Label the shipment as transport of a highly sensitive measuring instrument.



Information on returns can be found under the heading "Service" on our local website.

8.3 Disposal

Incorrect disposal can put the environment at risk.

Dispose of instrument components and packaging materials in an environmentally compatible way and in accordance with the country-specific waste disposal regulations.

9. Specifications

Differential pressure transmitter, model A2G-50

	Variant 1	Variant 2	Variant 3
Measuring element	Piezo measuring cell		
Measuring range	0 ... 2,500 Pa ¹⁾ 0 ... 2,000 Pa ²⁾ 0 ... 1,500 Pa ²⁾ 0 ... 1,000 Pa ²⁾ 0 ... 500 Pa ²⁾ 0 ... 250 Pa ²⁾ 0 ... 100 Pa ²⁾ -100 ... +100 Pa ²⁾	0 ... 7,000 Pa ¹⁾ 0 ... 5,000 Pa ²⁾ 0 ... 4,000 Pa ²⁾ 0 ... 3,000 Pa ²⁾ 0 ... 2,500 Pa ²⁾ 0 ... 2,000 Pa ²⁾ 0 ... 1,500 Pa ²⁾ 0 ... 1,000 Pa ²⁾	-250 ... +250 Pa ¹⁾ -100 ... +100 Pa ²⁾ -50 ... +50 Pa ²⁾ -25 ... +25 Pa ²⁾ 0 ... 250 Pa ²⁾ 0 ... 100 Pa ²⁾ 0 ... 50 Pa ²⁾ 0 ... 25 Pa ²⁾
	8 measuring ranges can be selected via jumpers		8 measuring ranges can be selected via jumpers
	Measuring ranges < 250 Pa: Autom. zero point setting (AZ) recommended		(Only available with autom. zero point setting (AZ))
	Option: Digital display (D), automatic zero point setting (AZ), digital display and automatic zero point setting (AZ-D)		
Accuracy	±1.5 % +1 Pa (of measured pressure)		
Units (adjustable in the menu)			
■ Air flow	m ³ /h, m ³ /s, l/s, cfm		
■ Differential pressure	Pa, kPa, mbar, inWC, mmWC		

9. Specifications

Differential pressure transmitter, model A2G-50

	Variant 1	Variant 2	Variant 3
Process connection	Connecting nozzle (ABS), lower mount, for hoses with inner diameter 4 or 6 mm		
Power supply U_B	AC 24 V or DC 24 V ± 10 %		
Electrical connection	Cable gland M16 Screw terminals max. 1.5 mm ²		
Output signal	DC 0 ... 10 V, 3-wire, 4 ... 20 mA, 3-wire		
Current consumption	< 1.0 W (0 ... 10 V), < 1.2 W (4 ... 20 mA), < 1.3 W (Modbus®)		
Case	Plastic (ABS)		
Permissible medium temperature	-10 ... +50 °C		
Ingress protection	IP54		
Weight	150 g		

EN

Modbus® version (option)





Modbus® communication

Protocol	Modbus® via serial interface
Transfer mode	RTU
Interface	RS-485
Byte format	(11 bits) in RTU mode Coding system: 8 bits binary Bits per byte: - 1 Start bit - 8 data bits, lowest-order bit is sent first - 1 bit for parity - 1 stop bit
Baud rate	9,600, 19,200, 38,400 - adjustable in the configuration
Modbus® addresses	1 ... 247 addresses - adjustable in the configuration

For further specifications see WIKA data sheet PE 88.02 and the order documentation.

10. Accessories

10. Accessories

Description	Order no.	
Connections for static duct probes for ¼" pipes		
	Insertion length 100 mm	40232956
	Insertion length 150 mm	40232964
	Insertion length 200 mm	40232972
Combi hose connection		
	Insertion length 100 mm	40232981
	Insertion length 150 mm	40232999
	Insertion length 200 mm	40233006
Measuring hoses		
	PVC hose, inner diameter 4 mm, roll at 25 m	40217841
	PVC hose, inner diameter 6 mm, roll at 25 m	40217850
	Silicone hose, inner diameter 4 mm, roll at 25 m	40208940
	Silicone hose, inner diameter 6 mm, roll at 25 m	40208958
Duct connector for hose 4 and 6 mm	40217507	
		

EN